

- Timber
- Aluminium
- Concrete

AUG 2025

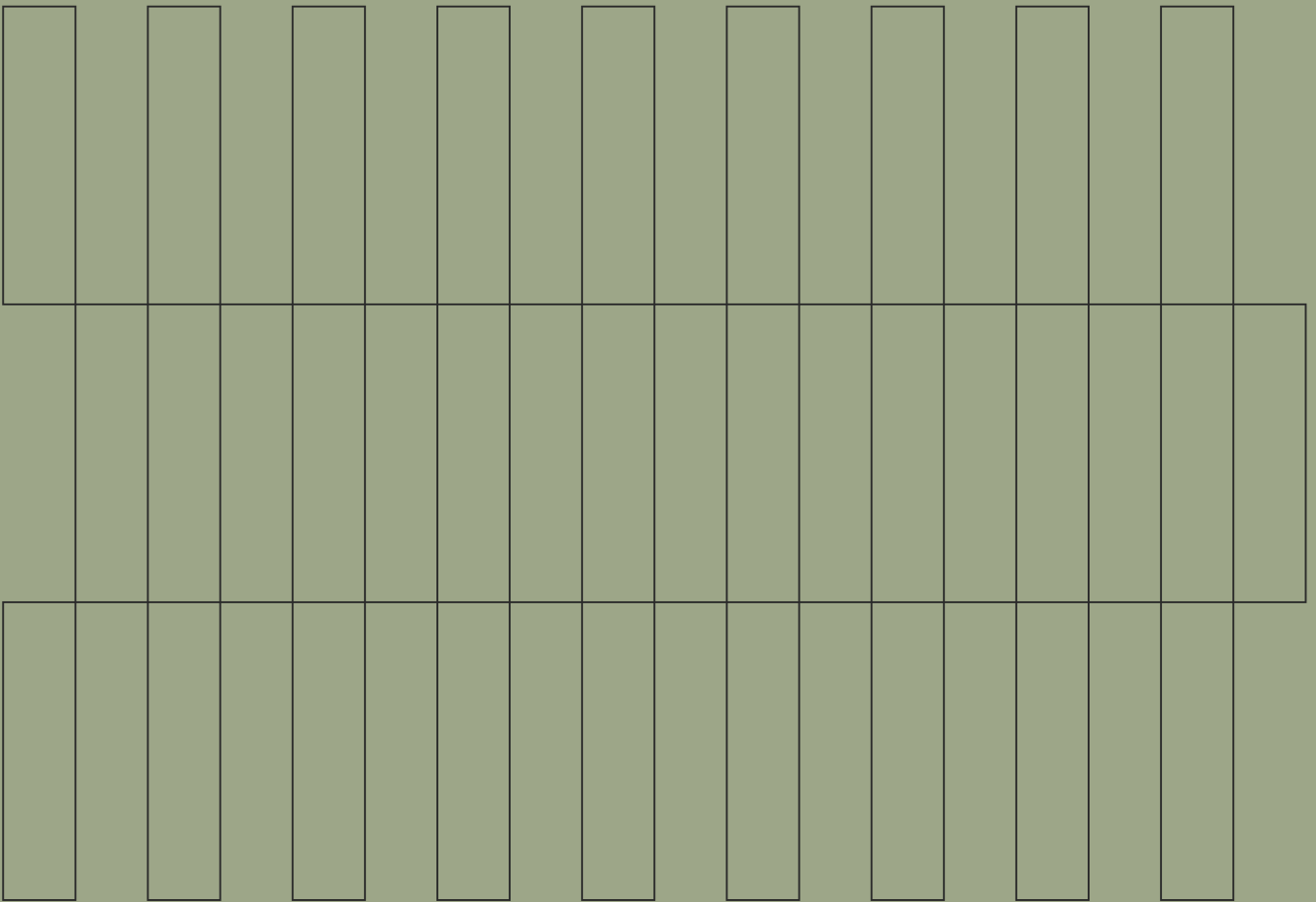

# Shiplap

Installation Guide

## Points to consider for successful design before installation:

### Moisture Content

Due to the hygroscopic nature of timber, it will adjust in moisture content according to ambient changes in temperature, humidity and weather exposure. As the moisture content changes, the timber expands and contracts.

### The following points need to be considered:

- Local climate
- Level of exposure to direct sunlight
- Allowance for expansion on large dimensions

### Long term weathering

A decision needs to be made at design stage whether to maintain the colour of the timber with an oil based timber preservative applied at regular intervals, or to allow the timber to weather naturally to a soft grey colour which requires minimal maintenance.

### Aspects for consideration:

- Committal of the client to long term maintenance  
Accessibility of the façade
- Desired aesthetic effort.
- If installed above other building materials, consider that natural tannin leaching can occur, due to rain, causing stains. This can be avoided by directing runoff water away from critical surfaces. Tannin is non-corrosive and is only of aesthetic concern.

### Flashing and waterproofing

All junctions and abutments with other surfaces need to be carefully considered. Sarking in combination with battened cladding needs to be detailed by a design professional. Modinex has flashings available for consideration.

## Limitation of butt joints

In vertical Cladding, butt joints can be limited by the use of a

Z flashing as an express joint. In horizontal cladding, sometimes vertical express joints can be introduced. This limits the need for large quantities of long lengths.

### Ideal for:

- Exterior architectural features
- Commercial cladding applications • Interior architectural features
- Municipal design
- Residential housing
- Rainforest retreats
- Hospitality building designs.

## Environmental credentials:

Modinex is fully committed to supplying the building and design industry with responsibly harvested timber products from carefully managed resources.

# Profiles

---



82mm wide

9mm, 12mm, 15mm and 18mm thickness available



133mm wide

9mm, 12mm, 15mm and 18mm thickness available

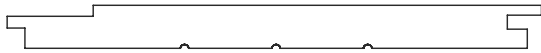

181mm wide

18mm thickness available

# Timber Species: Softwood

---



Western Red Cedar

Plantation  
100% PEFC Certified  
Greentag Certified



Western Red Cedar - Tight Knot

Plantation  
100% PEFC Certified



Hemlock

Plantation  
100% PEFC Certified  
Suitable for indoor and out-of weather use only



Hemlock - Thermally Modified

Plantation  
100% PEFC Certified

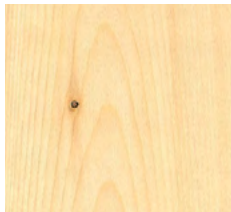

Alaskan Cedar

Plantation  
100% PEFC Certified



Accoya

Plantation  
100% PEFC Certified

## Timber Species: Hardwood

---



American Oak

PEFC Certification is available

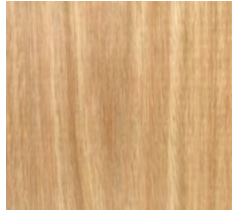

Blackbutt

FSC Certification is available

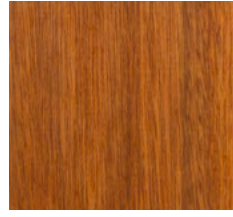

Spotted Gum

FSC Certification is available

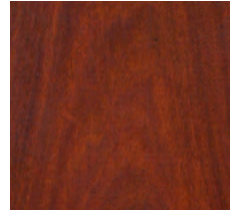

Ironbark

FSC Certification is available

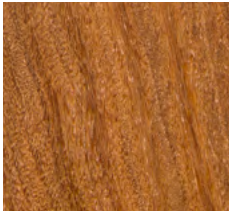

Southern Spotted

PEFC Certification is available



French Oak

PEFC Certification is available

## Timber Finishes

---

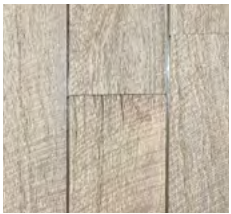

Circular Sawn



Band Sawn



Shot Blasted



Wire Brushed

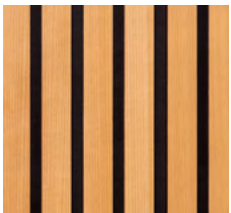

TwoTone

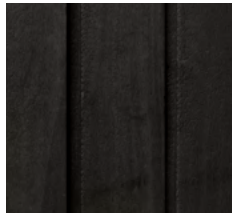

Charred - Shuo Sugi Ban



Dressed

## Installation instructions:

### Horizontal installation instructions:

1. Pre coat the cladding boards all round prior to installation and group similar lengths together for efficient optimization. Take advantage of our pre-oiling service, to save time, labour and space on site, providing an even coating on all 4 sides of the boards.

### Pre-oiling system

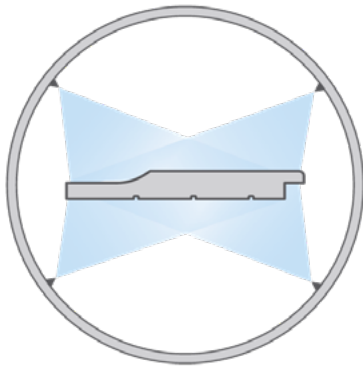

Eliminates process of manually oiling each board all-round prior to installation.

Gives the penetrating oil a chance to soak in prior to handling the timber.

The deeply penetrating oil, working from front & back of the board, improves dimensional stability.

Requires a topcoat after installation.

2. Install impermeable sarking over the stud frame keeping all overlaps pointing downwards and tape all joints.
3. Check stud work for straightness and plumb. Ensure correct provision had been made for external corner stop fixing. Studs to be max. 450 mm centres.

4. Install all corner stops and end stops (or aluminium trims).
5. Install starter board checking for level at all points.
6. Using a gauging stick, mark the cover increments of each row up the studs off the top of the starter board to keep everything straight and parallel. This is particularly important around windows and doors. Alternatively use a spacer block in the shadow line to assist even spacing.
7. Install the cladding boards, following the increments marked on the studs. In some tropical climates the 2mm expansion allowance may need to be increased due to high moisture conditions. It may be necessary to lubricate the gaskets in the end stops with dishwashing liquid to help slip the boards in easily. Predrill a countersunk and clearance hole prior to drilling in the screws. If nailing, ensure nails are installed with the head flush to the surface of the timber. Do not drive in deeper as this may cause the timber to crack, losing the holding power of the nail.
8. Butt joints should be joined on the studs. All butt joints should be sealed with 'sikaflex' or similar joint sealant. The easiest way to apply the joint sealant is to apply it to the end of one board and allow it to squeeze out as the two boards are pushed together. The excess sealant will mushroom off the two edges. Let it dry fully, and then scrape it flush with a sharp chisel.
9. All end grain is to be sealed with multiple coats of the timber preservative to be used on the face.

#### Face fixing showing fixing position

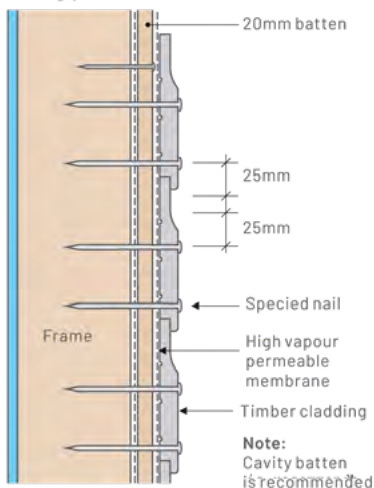

Horizontal installation - external

#### Expansion gap located at every storey

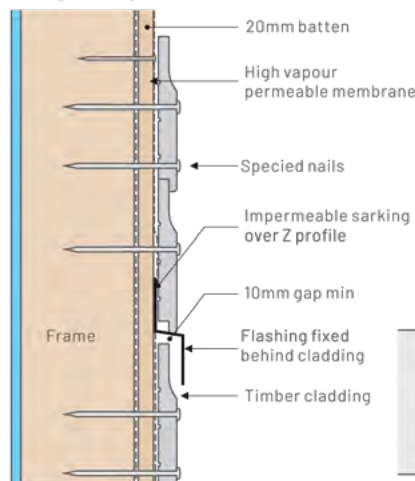

#### Minimum clearance of cladding above final ground levels and finishing below bottom

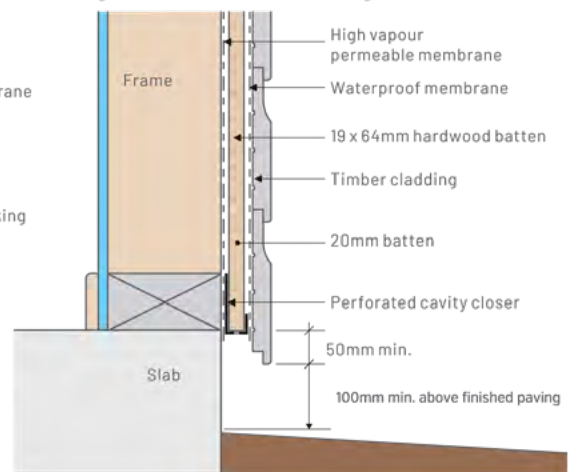

## Vertical installation instructions:

1. Pre coat the cladding boards all round prior to installation and group similar lengths together for efficient optimisation. Take advantage of our pre-oiling service, to save time, labour and space on site, providing an even coating on all 4 sides of the boards.
2. Install impermeable sarking over the stud frame keeping all overlaps pointing downwards and tape all joints. Attach horizontal battens at 450 mm centres. These may be packed out to ensure straightness if necessary. Use 70x35 mm pine framing or similar material.
3. Install all external corner stops, Z flashings and bottom angles onto the horizontal battens.
4. Using a gauging stick, mark the cover increments of each row along the battens to keep everything straight and parallel. This is particularly important around openings. Alternatively use a spacer block in the shadow line to assist even spacing.
5. Install the cladding boards following the increments marked on the battens. In some tropical climates, the 2mm expansion allowance may need to be increased due to high moisture conditions.
6. Pre-drill a countersunk and clearance hole prior to drilling in the screws. If nailing, ensure nails are installed with the head flush to the surface of the timber. Do not drive in deeper as this may cause the timber to crack, losing the holding power of the nail.

## Stud Frame Detail Typical vertical installation

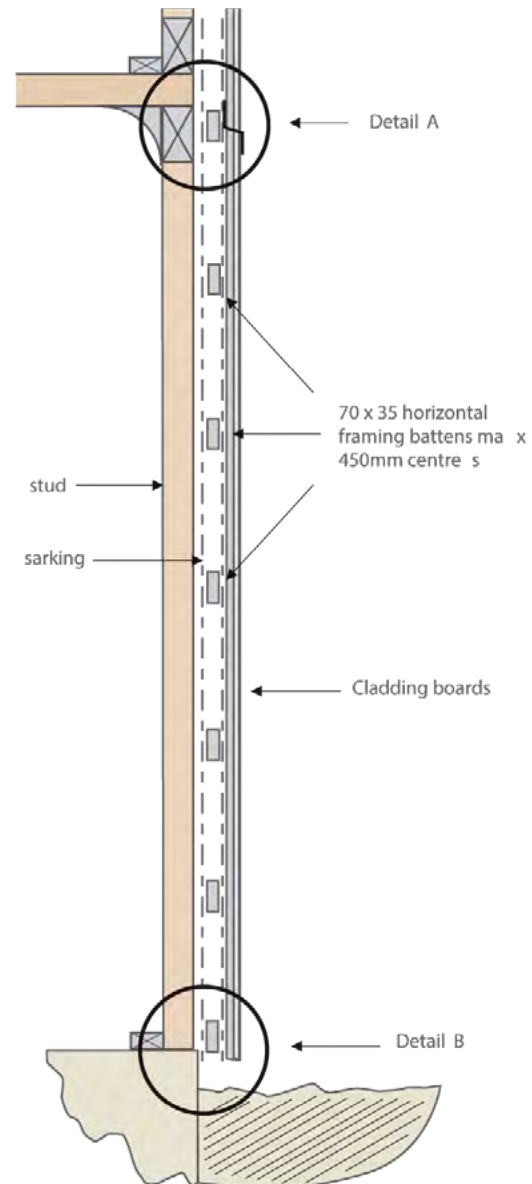

### Expansion Gap Detail A

Vertical installation

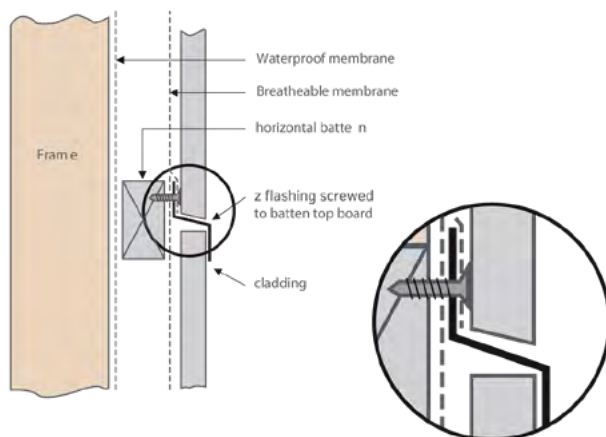

### Bottom Edge – Detail B

Vertical installation

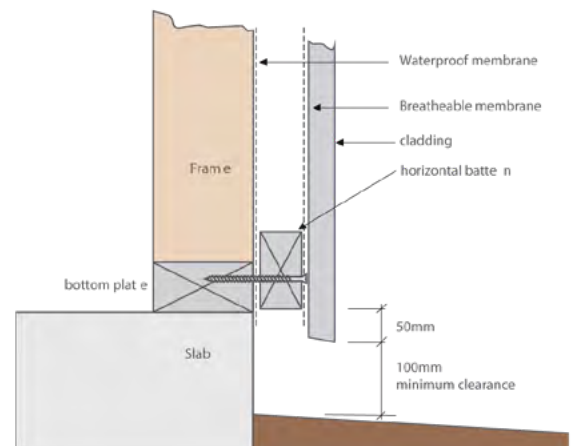

## Section details

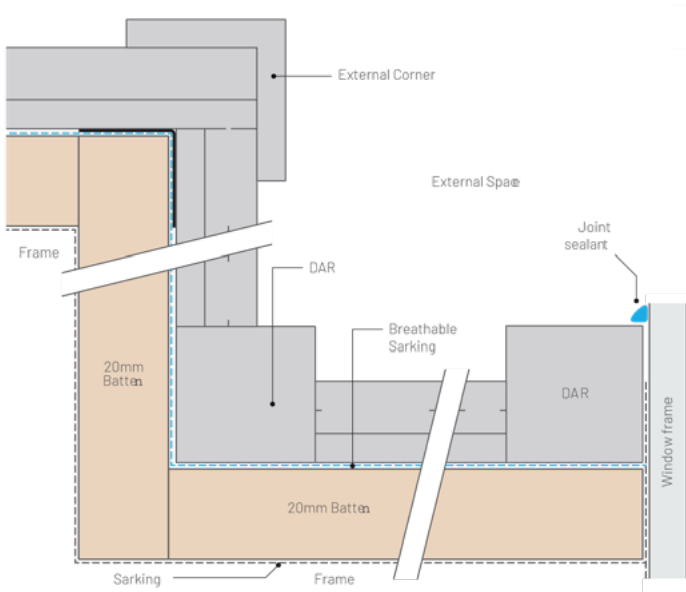

**Internal / external stops (timber)**

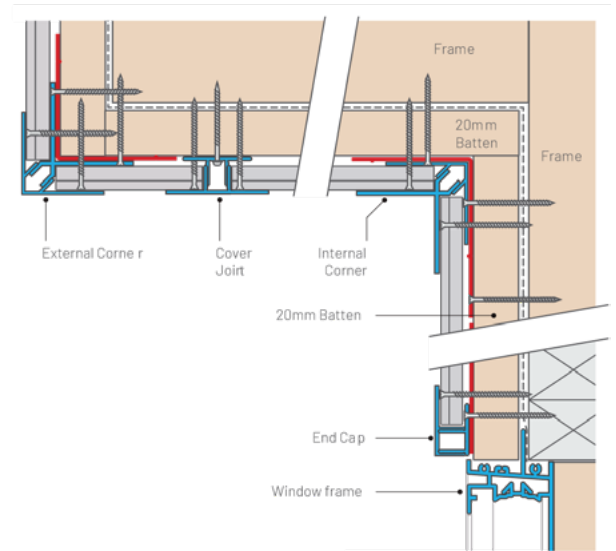

**Internal / external stops (Aluminium)**

## Range of movement

It is necessary to predict, as far as possible, the range of movement to be expected in a given application. This can then be allowed for by: leaving room for expansion between the boards, expansion joints if necessary, choosing suitable species or changing the width of a board.

The following factors influence movement:

- Tangential shrinkage rate of the species (rate of shrinkage across the width of a backsawn board).
- Annual cycle of weather
- Level of exposure to sun/weather i.e. Direction, overhanging eaves, shadows etc.
- Size of the area to be clad.
- Waterproofing and water runoff
- Weather protection in construction.

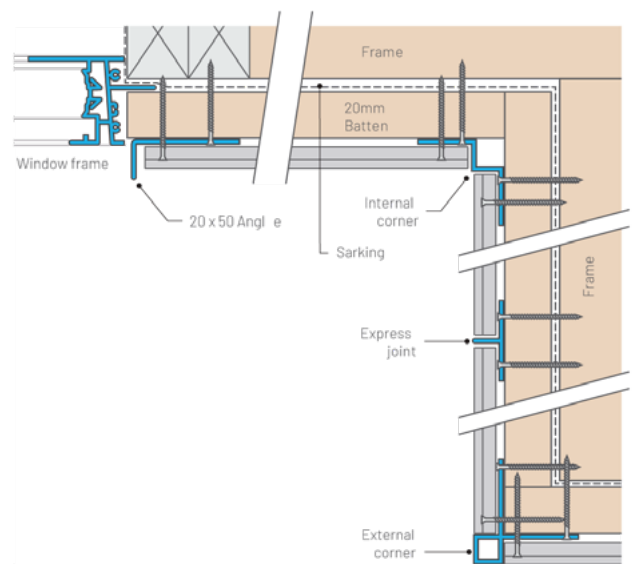

**Hidden Interior / external stops (aluminium) extra detail**

## Concealed fixing details for internal installations:

1. Check stud work for straightness and plumb. Ensure correct provision had been made for external corner stop fixing. Studs to be max. 450 mm centres.
2. Install all corner stops and end stops.
3. Install starter board checking for level at all points.
4. Using a gauging stick, mark the cover increments of each row up the studs off the top of the starter board to keep every- thing straight and parallel. This is particularly important around windows and doors. Alternatively use a spacer block in the shadow line to assist even spacing.
5. Install the cladding boards, following the increments marked on the studs. In some tropical climates the 2mm expansion allowance may need to be increased due to high moisture conditions. It may be necessary to lubricate the gaskets in the end stops with dishwashing liquid to help slip the boards in easily. Predrill a countersunk and clearance hole prior to drilling in the screws. If nailing, ensure nails are installed with the head flush to the surface of the timber. Do not drive in deeper as this may cause the timber to crack, losing the holding power of the nail.
6. Butt joints should be joined on the studs. All butt joints should be sealed with 'sikaflex' or similar joint sealant. The easiest way to apply the joint sealant is to apply it to the end of one board and allow it to squeeze out as the two boards are pushed together. The excess sealant will mushroom off the two edges. Let it dry fully, and then scrape it flush with a sharp chisel.
7. All end grain is to be sealed with multiple coats of the timber preservative to be used on the face.

The standard profile design allows 2 mm expansion and 7 mm contraction which is sufficient for normal conditions. The important thing is to identify the possibility of excessive conditions and make sure these are provided for. Modinex offer the service, on request, of calculating the maximum moisture content and hence the expansion and contraction in an area based on the information provided by the Bureau of Meteorology and the tangential shrinkage factor.

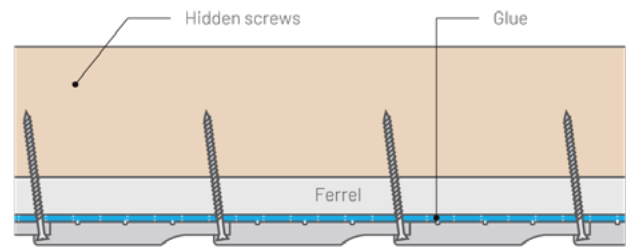

Horizontal installation – internal ceiling

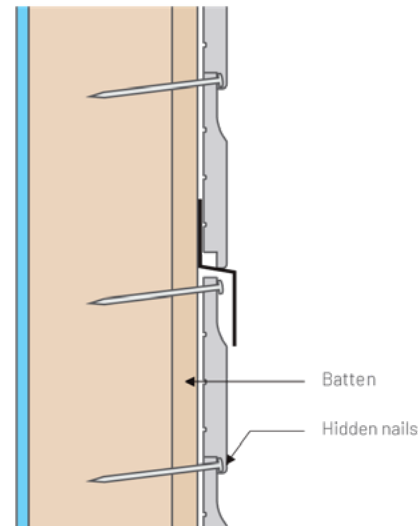

Horizontal installation – internal wall

## Design specification

To assist in achieving your desired result, the following information should be drafted into your project specifications to ensure that inferior products are not used on your project. All denoted façade areas to be Shiplap Cladding, supplied according to the following specification and installed in accordance with the Building Codes of Australia, and the manufacturer's installation guidelines.

## Surface finish

Furniture grade smoothness, ready for oiling – top surface only. Minimal chipping may occur with interlocking grain.

## Surface finish

Within a range of 10-14% M/C

## Straightness

Max warp/bow – 7 mm per metre.

## Grade

Natural Select (min 2/3 Select, max 1/3 Standard according to AS 2796.2) Minimal surface checking allowed. Graded top face only.

## Length

All timber is supplied in random length, ranging from 0.9m to 6.0m, unless otherwise specified. Average length = +/-2.7m. Max of 15% under 1.8m.

## Colour Selection

Colour selection is not part of the grading process except with extreme variations according to the discretion of Modinex. Colours can vary significantly from rich browns to greys. This is a natural characteristic of timber.

## Species Selection

All timber selected according to species classification as covered in known trade names, i.e; Spotted Gum, Ironbark and Blackbutt. Other species are available upon request.

## Durability Rating (AS 5604)

Above ground durability rating for Blackbutt, Spotted Gum and Ironbark cladding is High or Class 1. Rosewood, Western Red Cedar and Pacific Teak have a Class Number 2 or Reasonably High.

## Specification Variance:

Up to 5% of volume. Pre-Oiling with Cutek Wood Preservative Option. This option provides the application of 1 clear coat of Cutek Wood Preservative to all 4 sides of each board. Further applications are required after installation to maintain the appearance of the timber – refer to timber finishes section.

## Profile Accuracy

Machining tolerance measured at time of manufacture is +/- 0.2 mm in dimension and profile. Due to variance in timber moisture and characteristics, boards may swell or contract individually when exposed to the elements.

## On-site storage & acclimatisation

All timber should be stored undercover, on bearers at least 50 mm above ground and with plenty of airflow.

- Timber that is not neatly stacked is much more likely to twist or warp.
- At least two weeks acclimatisation period is necessary in areas of extreme weather conditions to avoid excessive expansion and contraction after

installation.

- The cladding boards could be coated at this stage if the timber has not been supplied preoiled.
- External cladding is one of the harshest applications for timber surface finishes due to the destructive UV rays of the hot Australian Sun. As a result, ease of maintenance is a prime consideration. We recommend a good quality oil which is very easily applied using a lamb's wool applicator

## Surface finishes

### Advantages of oils

- Brings out the natural beauty and character of the timber.
- Penetrates and feeds the timber, providing dimensional stability
- Allows the timber to breathe.
- Tends to disappear and thin out when breaking down without blistering and peeling.
- Can be quickly reapplied by an unskilled person using a lamb's wool applicator.

We recommend and supply the Cutek Wood Preservative system. Ask for a Cutek brochure for further details.

It is important to note that a clear coating on exterior wood surfaces will quickly lighten/silver in a few months of direct sun exposure. It gives a beautiful natural look associated with timber. If however you wish to delay the weathered look of the timber then apply a Colourtone to the Oil to provide some UV protection giving the cladding a freshly oiled timber aesthetic.

## Maintenance

Natural timber needs maintenance. Maintenance is required regardless of whether you want the rich pristine 'coated' timber look or the natural greyed off affect. The timber cells need to be hydrated and fed, to avoid them separating and shrivelling up which results in cracking and twisting. The frequency of oil application required depends on the following factors:

- Level of exposure to the sun
- Level of local rainfall
- The level of UV block provided by the coating
- The extent of exposure to the western sun

Modinex recommends Cutek oils and the coating must be reapplied as frequently as necessary to retain the natural beauty and colour of the timber.

## Face fixing of lining

Tables 1 and 2 provide further details on specific nail types and sizes for face fixing of lining for different underlying framing of 80 mm lining boards, respectively.

All nails are to be flat, D or bullet headed. The recommended nail diameter should not be exceeded otherwise splitting may occur.

Where lining is installed over a cavity the battens need to be fixed to studs as per minimum recommendations detailed under each lining installation method.

Table 1: Minimum hand driven nail sizes for face fixing of 80mm lining boards to timber framing or cavity battens

Timber framing/ batten type	Hardwood	Softwood
Nail size and type	50 x 2.0mm plain	60 x 2.8mm twisted or annular treaded
Minimum penetration	30mm	40mm

Table 2: Minimum hand driven nail sizes for face fixing of 130mm lining boards to timber framing or cavity battens

Timber framing/ batten type	Hardwood	Softwood
Nail size and type	50 x 2.0mm plain	60 x 2.8mm twisted or annular treaded
Minimum penetration	30mm	40mm

Nails should be placed at least 15 mm from the edge and end of lining board.

Where machine nails or screws are used they need to be equivalent in performance to nails defined in Table 1 and 2.

As machine nails and screws vary from manufacturer to manufacturer, the manufacturer should be consulted regarding the adequacy of the fixing.

T-nails should never be used.

### Face fixing showing fixing position

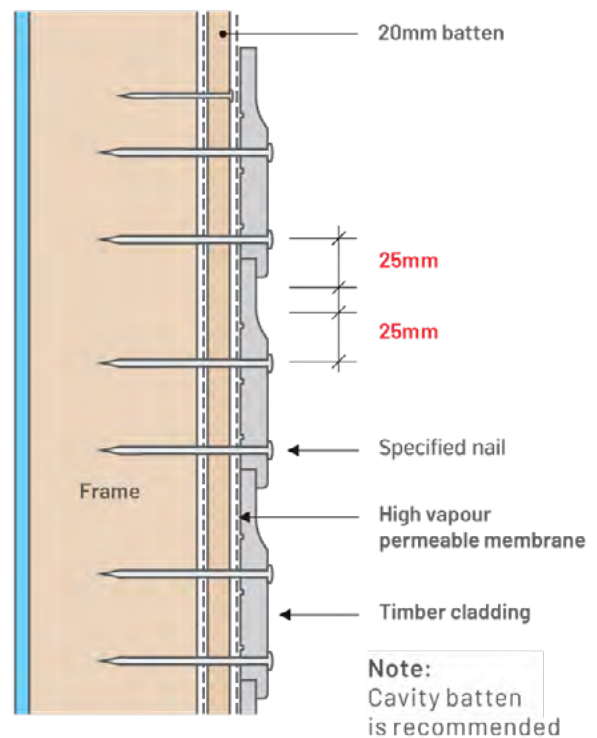

## Secret fixing of lining

Lining profiles may be secret fixed using one fixing per intersection with batten, stud or bottom chord - driven into tongue at an angle. See Figure below from Internal Section of attached install Guide - page 6.

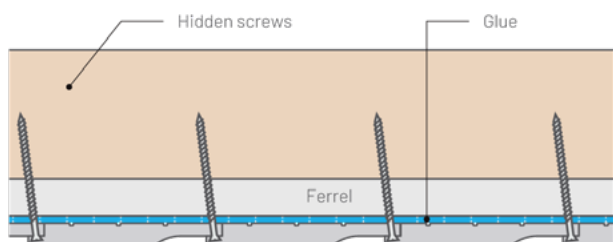

Horizontal installation - internal ceiling

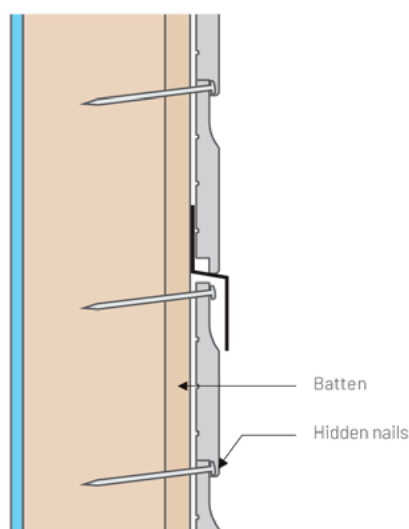

Horizontal installation - internal wall

Secret fixed boards also need to be glued to the batten. A continuous bead (6 mm to 10 mm approximately) of adhesive rated for exterior use is to be applied to the batten before fixing.

Tables 3 and 4 provide further details on specific nail types and sizes for secret fixing of lining for different underlying framing of 80 mm lining boards, respectively. All nails to be flat, D or bullet headed.

The recommended nail diameter should not be exceeded otherwise splitting may occur. Where lining is installed over a cavity the battens need to be fixed to studs as per minimum recommendations detailed under each lining installation method.

Table 3: Minimum hand driven nail sizes for face fixing of 80mm lining boards to timber framing or cavity battens

Timber framing/ batten type	Hardwood	Softwood
Nail size and type	50 x 2.0mm plain	60 x 2.8mm twisted or annular treaded
Minimum penetration	30mm	40mm

Table 4: Minimum hand driven nail sizes for face fixing of 130mm lining boards to timber framing or cavity battens

Timber framing/ batten type	Hardwood	Softwood
Nail size and type	50 x 3.75mm plain	60 x 3.75mm twisted or annular treaded
Minimum penetration	30mm	40mm

## Soffits and eaves

For design of soffits, external ceiling and eaves in terms of connections and sub structure please refer to cladding design and installation sections.

## Suggested adhesives

Gorilla Glue provides strong adhesion to metal and wood. It's waterproof, so it is good for indoor or outdoor use. It can also be sanded, stained and painted.

