

- Timber
- Aluminium
- Concrete

MAY 2026

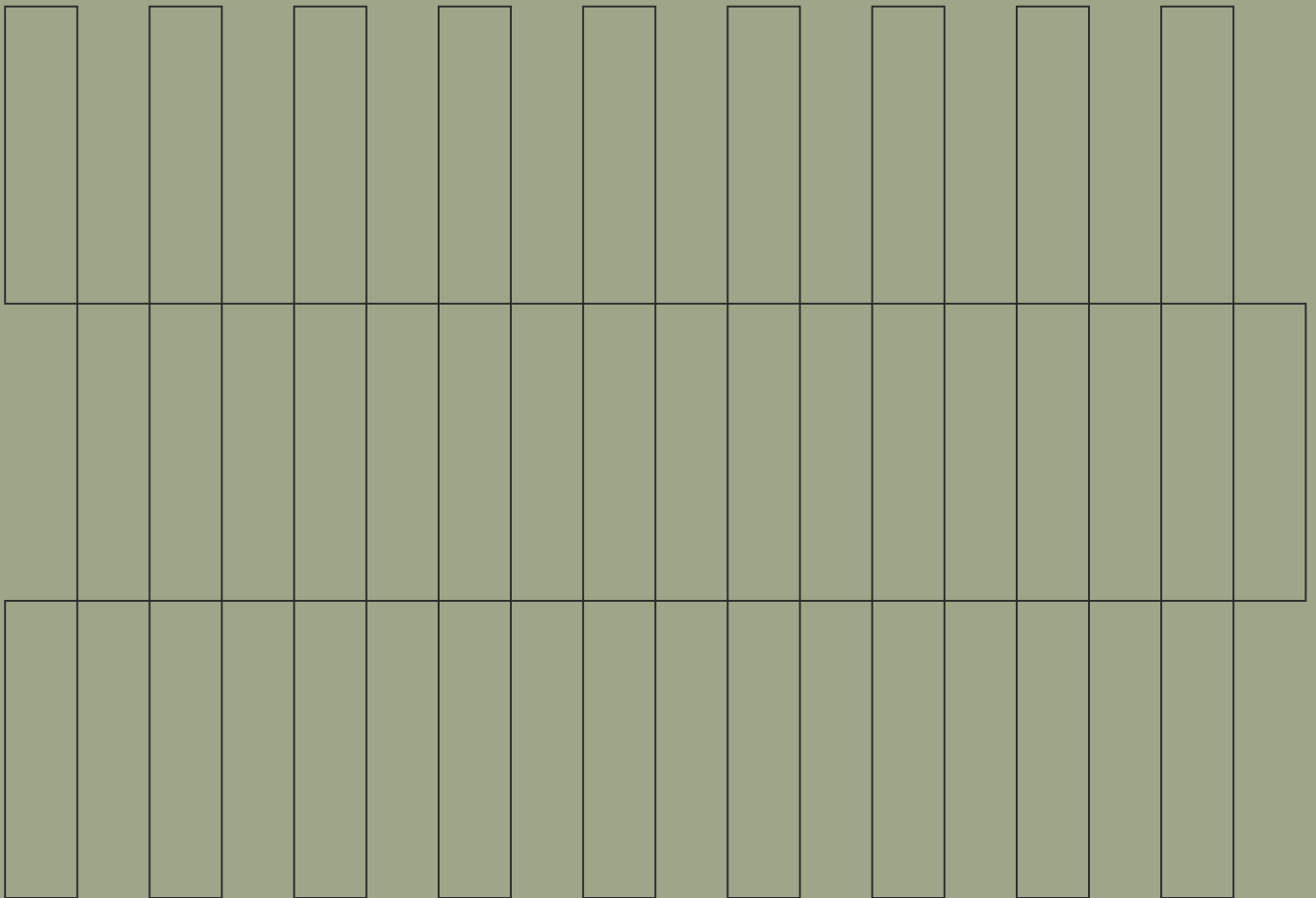

External Hardwood Cladding

Installation Guide

Bespoke timber —
Architectural signatures

modinex.com.au

Points to consider for successful design before installation:

Moisture content

Due to the hygroscopic nature of timber, it will adjust in moisture content according to ambient changes in temperature, humidity and weather exposure. As the moisture content changes, the timber expands and contracts.

The following points need to be considered:

- Local climate
- Level of exposure to direct sunlight
- Allowance for expansion on large dimensions
- All cut edges must be sealed in the same manner as the board face

Long term weathering

A decision needs to be made at design stage whether to maintain the colour of the timber with an oil based timber preservative applied at regular intervals, or to allow the timber to weather naturally to a soft grey colour which requires minimal maintenance.

Aspects for consideration:

- Committal of the client to long term maintenance
- Accessibility of the façade
- Desired aesthetic effort.
- If installed above other building materials, consider that natural tannin leaching can occur, due to rain, causing stains. This can be avoided by directing runoff water away from critical surfaces. Tannin is non-corrosive and is only of aesthetic concern.

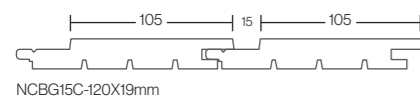
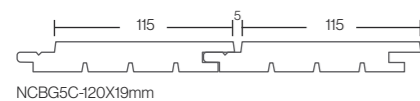

Colours/Species

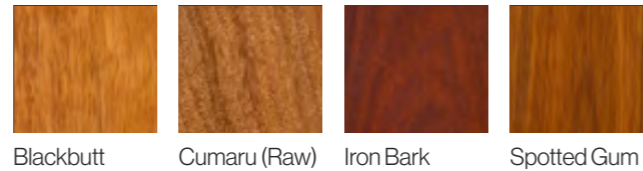

Flashing and waterproofing

All junctions and abutments with other surfaces need to be carefully considered. Sarking in combination with battened cladding needs to be detailed by a design professional. Modinex has flashings available for consideration

Limitation of butt joints

In vertical Cladding, butt joints can be limited by the use of a Z flashing as an express joint. In horizontal cladding, sometimes vertical express joints can be introduced. This limits the need for large quantities of long lengths.

Ideal for:

- Exterior architectural features
- Commercial cladding applications
- Interior architectural features
- Municipal design
- Residential housing
- Rainforest retreats
- Hospitality building designs.

Environmental credentials:

Modinex is fully committed to supplying the building and design industry with responsibly harvested timber products from carefully managed resources.

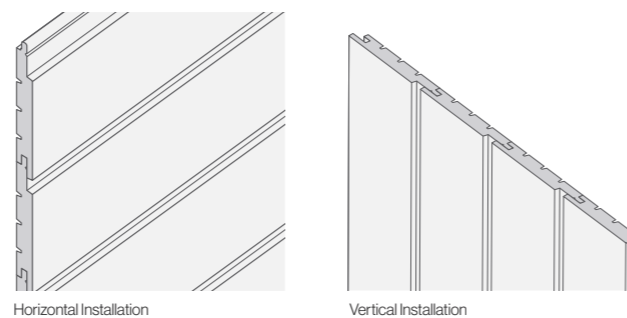

Installation instructions:

Elevation-Specific Installation Notes: All Hardwood Claddings

These notes apply to all external hardwood cladding installations. Where charred or dark oiled boards are specified, strict compliance is essential. Both finishes absorb and retain significantly more heat than standard timber, increasing thermal movement and board stress.

North & West Elevations

- Cladding width: 6-inch for flat profiles (ex. 150mm feedstock); 4-inch for grooved/castellated profiles (ex. 100mm feedstock).
- Boards are fixed with a 1mm packer gap on every second board. 1st board up tight, 2nd board with 1mm tolerance, repeat.
- All cut ends and rips to be sealed with oil. Charred claddings also require char applied to cut ends and rips.
- Pre-drill and fix with Sikaflex, using screw size and gauge appropriate to the substrate batten size.
- If cladding is butt-joined or end-matched, apply Sikaflex to the end join.
- Apply a full topcoat of oil once installation is complete.

South & East Elevations

- Cladding width: 6-inch profiles recommended (ex. 150mm feedstock).
- Boards are fixed with a 1mm packer gap between every board.
- All cut ends and rips to be sealed with oil. Charred claddings also require char applied to cut ends and rips.
- Pre-drill and fix with Sikaflex, using screw size and gauge appropriate to the substrate batten size.
- Apply a full topcoat of oil once installation is complete.

Horizontal installation instructions:

1. Pre coat the cladding boards all round prior to installation and group similar lengths together for efficient optimization. Take advantage of our pre-oiling service, to save time, labour and space on site, providing an even coating on all 4 sides of the boards.

Pre-oiling system

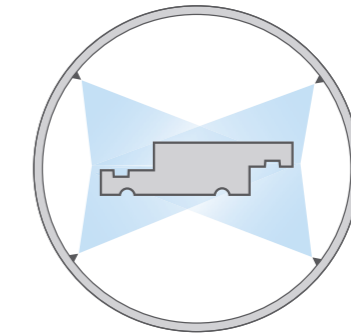

Eliminates process of manually oiling each board all-round prior to installation.

Gives the penetrating oil a chance to soak in prior to handling the timber.

The deeply penetrating oil, working from front & back of the board, improves dimensional stability.

Requires a topcoat after installation.

2. Install impermeable sarking over the stud frame keeping all overlaps pointing downwards and tape all joints.
3. Check stud work for straightness and plumb. Ensure correct provision had been made for external corner stop fixing. Studs to be max. 450 mm centres.
4. Install all corner stops and end stops (or aluminium trims).
5. Install starter board checking for level at all points
6. Using a gauging stick, mark the cover increments of each row up the studs off the top of the starter board to keep everything straight and parallel. This is particularly important around windows and doors. Alternatively use a spacer block in the shadow line to assist even spacing.

- Install the cladding boards, following the increments marked on the studs. In some tropical climates the 2mm expansion allowance may need to be increased due to high moisture conditions. It may be necessary to lubricate the gaskets in the end stops with dishwashing liquid to help slip the boards in easily. Pre-drill a countersunk and clearance hole prior to drilling in the screws. If nailing, ensure nails are installed with the head flush to the surface of the timber. Do not drive in deeper as this may cause the timber to crack, losing the holding power of the nail.
- Butt joints should be joined on the studs. All butt joints should be sealed with 'sika-flex' or similar joint sealant. The easiest way to apply the joint sealant is to apply it to the end of one board and allow it to squeeze out as the two boards are pushed together. The excess sealant will mushroom off the two edges. Let it dry fully, and then scrape it flush with a sharp chisel.
- All end grain is to be sealed with multiple coats of the timber preservative to be used on the face.

Vertical installation instructions:

- Pre-coat the cladding boards all round prior to installation and group similar lengths together for efficient optimisation. Take advantage of our pre-oiling service, to save time, labour and space on site, providing an even coating on all 4 sides of the boards.
- Install impermeable sarking over the stud frame keeping all overlaps pointing downwards and tape all joints. Attach horizontal battens at 450 mm centres. These may be packed out to ensure straightness if necessary. Use 70x35 mm pine framing or similar material.
- Install all external corner stops, Z flashings and bottom angles onto the horizontal battens.
- Using a gauging stick, mark the cover increments of each row along the battens to keep everything straight and parallel. This is particularly important around openings. Alternatively use a spacer block in the shadow line to assist even spacing.
- Install the cladding boards following the increments marked on the battens. In some tropical climates, the 2mm expansion allowance may need to be increased due to high moisture conditions.
- Pre-drill a countersunk and clearance hole prior to drilling in the screws. If nailing, ensure nails are installed with the head flush to the surface of the timber. Do not drive in deeper as this may cause the timber to crack, losing the holding power of the nail.

Stud Frame Detail: Typical Vertical Installation

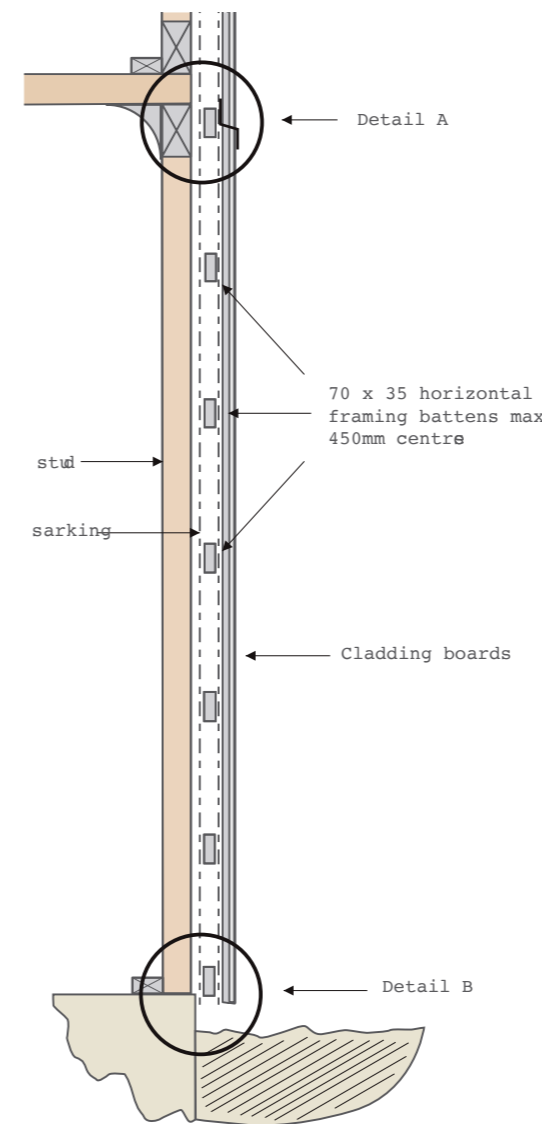

Expansion Gap Detail A

Vertical Installation

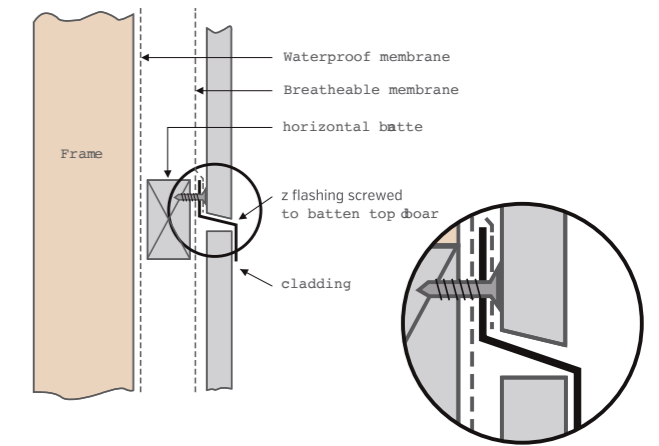

Bottom Edge - Detail B

Vertical Installation

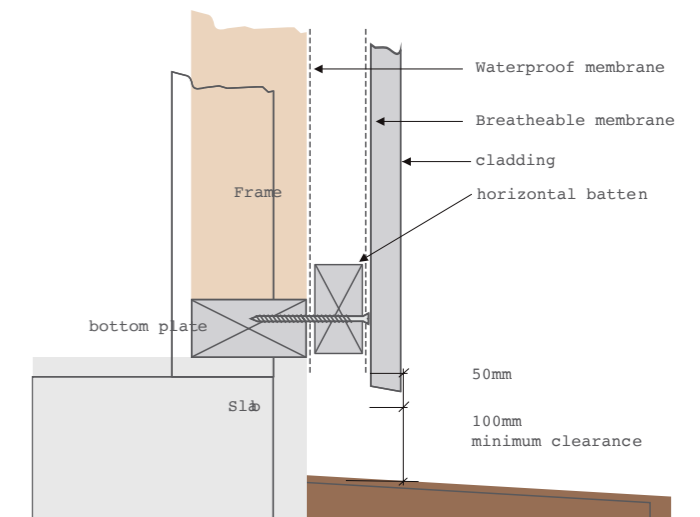

Face fixing showing fixing position

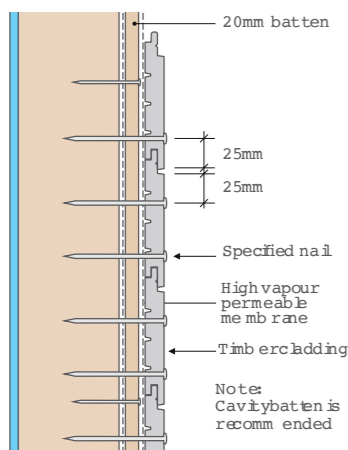

Face fixing showing fixing position

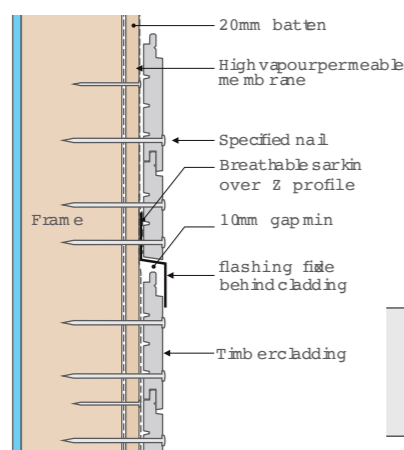

Minimum clearance level of cladding above final ground levels and finishing below bottom plate

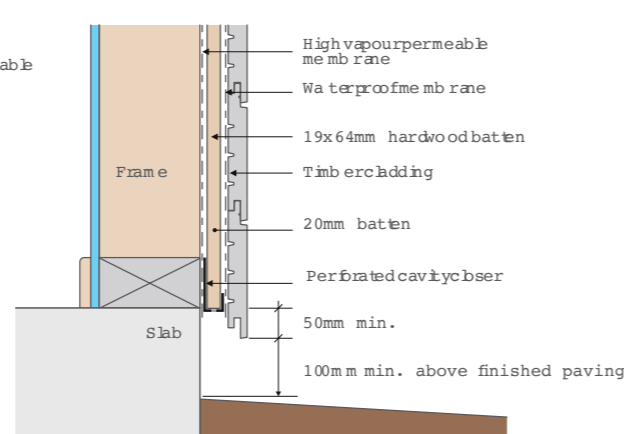

Horizontal installation - external

Section details

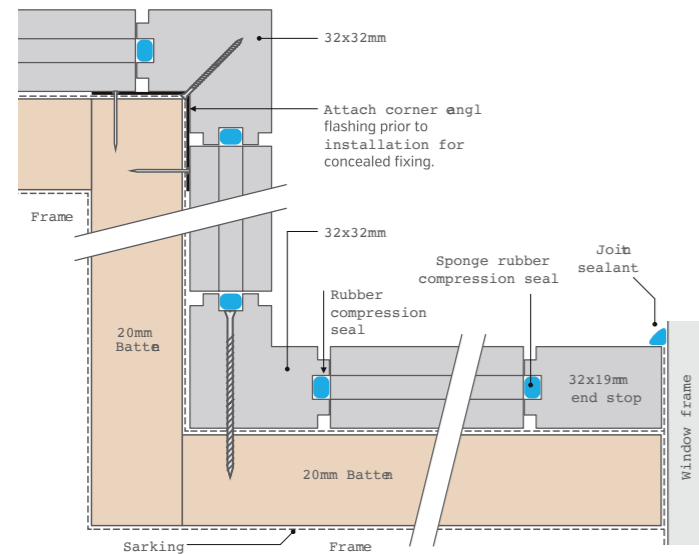

Internal / external stops (timber)

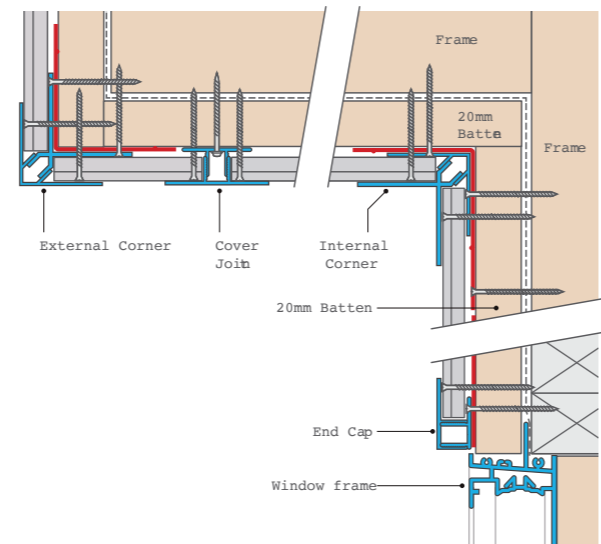

Internal / external stops (Aluminium)

Note: These flashings will not work with the 26mm or 38mm deep profiles.

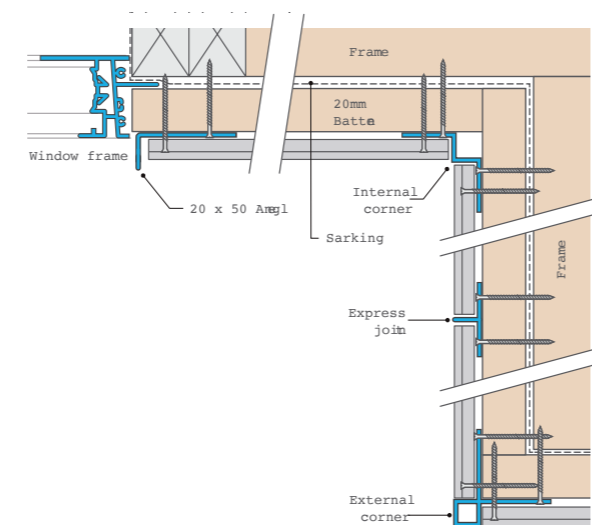

Hidden Interior / external stops (aluminium) extra detail

Range of movement

It is necessary to predict, as far as possible, the range of movement to be expected in a given application. This can then be allowed for by: leaving room for expansion between the boards, expansion joints if necessary, choosing suitable species or changing the width of a board.

The following factors influence movement:

- Tangential shrinkage rate of the species (rate of shrinkage across the width of a backsawn board).
- Annual cycle of weather
- Level of exposure to sun/weather i.e. Direction, overhanging eaves, shadows etc.
- Size of the area to be clad.
- Waterproofing and water run off.
- Weather protection in construction.

Concealed fixing details for internal installations:

1. Check stud work for straightness and plumb. Ensure correct provision had been made for external corner stop fixing. Studs to be max. 450 mm centres.
2. Install all corner stops and end stops.
3. Install starter board checking for level at all points.
4. Using a gauging stick, mark the cover increments of each row up the studs off the top of the starter board to keep everything straight and parallel. This is particularly important around windows and doors. Alternatively use a spacer block in the shadow line to assist even spacing.
5. Install the cladding boards, following the increments marked on the studs. In some tropical climates the 2mm expansion allowance may need to be increased due to high moisture conditions. It may be necessary to lubricate the gaskets in the end stops with dishwashing liquid to help slip the boards in easily. Pre-drill a countersunk and clearance hole prior to drilling in the screws. If nailing, ensure nails are installed with the head flush to the surface of the timber. Do not drive in deeper as this may cause the timber to crack, losing the holding power of the nail.
6. Butt joints should be joined on the studs. All butt joints should be sealed with 'sikaflex' or similar joint sealant. The easiest way to apply the joint sealant is to apply it to the end of one board and allow it to squeeze out as the two boards are pushed together. The excess sealant will mushroom off the two edges. Let it dry fully, and then scrape it flush with a sharp chisel.
7. All end grain is to be sealed with multiple coats of the timber preservative to be used on the face.

The standard profile design allows 2 mm expansion and 7 mm contraction which is sufficient for normal conditions. The important thing is to identify the possibility of excessive conditions and make sure these are provided for.

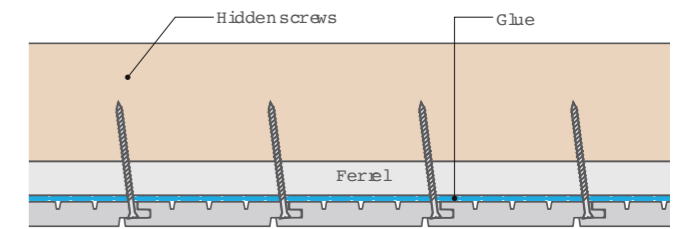

Horizontal installation - internal ceiling

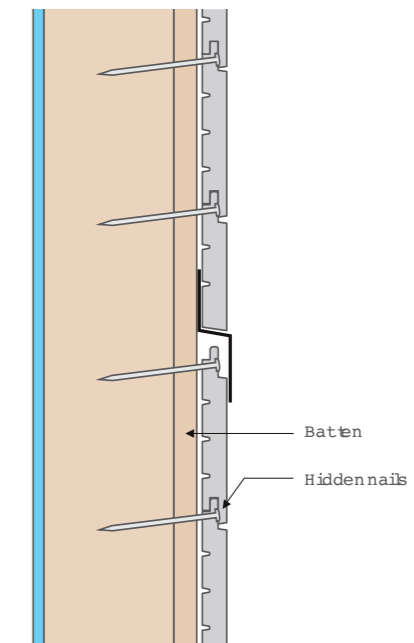

Horizontal installation - internal wall

Design specification

To assist in achieving your desired result, the following information should be drafted into your project specifications to ensure that inferior products are not used on your project. All denoted façade areas to be Shiplap Cladding, supplied according to the following specification and installed in accordance with the Building Codes of Australia, and the manufacturer's installation guidelines.

Surface finish

Furniture grade smoothness, ready for oiling – top surface only. Minimal chipping may occur with interlocking grain.

Moisture content

Within a range of 10-14% M/C

Straightness

Max warp/bow – 7 mm per metre.

Grade

Natural Select (min 2/3 Select, max 1/3 Standard according to AS 2796.2) Minimal surface checking allowed. Graded top face only.

Length

All timber is supplied in random length, ranging from 0.9m to 6.0m, unless otherwise specified. Average length = +/-2.7m. Max of 15% under 1.8m.

Colour selection

Colour selection is not part of the grading process except with extreme variations according to the discretion of Modinex. Colours can vary significantly from rich browns to greys. This is a natural characteristic of timber.

Species selection

All timber selected according to species classification as covered in known trade names, i.e; Spotted Gum, Ironbark and Blackbutt. Other species are available upon request.

Durability Rating (AS 5604)

Above ground durability rating for Blackbutt, Spotted Gum and Ironbark cladding is High or Class 1. Rosewood, Western Red Cedar and Pacific Teak have a Class Number 2 or Reasonably High.

Specification variance:

Up to 5% of volume. Pre-Oiling with Cutek Wood Preservative Option. This option provides the application of 1 clear coat of Cutek Wood Preservative to all 4 sides of each board. Further applications are required after installation to maintain the appearance of the timber – refer to timber finishes section.

Profile accuracy

Machining tolerance measured at time of manufacture is +/- 0.2 mm in dimension and profile. Due to variance in timber moisture and characteristics, boards may swell or contract individually when exposed to the elements.

On-site storage & acclimatisation

All timber should be stored undercover, on bearers at least 50 mm above ground and with plenty of airflow.

- Timber that is not neatly stacked is much more likely to twist or warp.
- At least two weeks acclimatisation period is necessary in areas of extreme weather conditions to avoid excessive expansion and contraction after installation.
- The cladding boards could be coated at this stage if the timber has not been supplied preoiled.
- External cladding is one of the harshest applications for timber surface finishes due to the destructive UV rays of the hot Australian Sun. As a result, ease of maintenance is a prime consideration. We recommend a good quality oil which is very easily applied using a lamb's wool applicator

Surface finishes

Advantages of oils

- Brings out the natural beauty and character of the timber.
- Penetrates and feeds the timber, providing dimensional stability
- Allows the timber to breathe.
- Tends to disappear and thin out when breaking down without blistering and peeling.
- Can be quickly reapplied by an unskilled person using a lamb's wool applicator.

We recommend and supply the Cutek Wood Preservative system. Ask for a Cutek brochure for further details. It is important to note that a clear coating on exterior wood surfaces will quickly lighten/silver in a few months of direct sun exposure. It gives a beautiful natural look associated with timber. If however you wish to delay the weathered look of the timber then apply a Colourtone to the Oil to provide some UV protection giving the cladding a freshly oiled timber aesthetic.

Ensuring longevity

When ordering timber for external use, it is best practise to ask for pre-oiling in a clear penetrating oil. This will then soak into the timber during transport and protect the “freshly machined” look, straight from the mill to site.

Once timber arrives on site, and acclimatises, we strongly advise fully coating all sides of the timber again in a high-quality penetrating oil. This will be your last chance to coat the rear face of the profile and will help ensure timber stability.

During the install process, recoat all cut ends and mitres, as these will be inaccessible once fully installed.

Once installation is completed, and the timber has been cleaned down, fully recoat the exposed faces and edges. This will help minimise the risk of water ingress through any penetration such as nails and screws, and reduce the visibility of marks of any marks left during the installation process.

Maintenance

Natural timber needs maintenance. Maintenance is required regardless of whether you want the rich pristine 'coated' timber look or the natural greyed off affect. The timber cells need to be hydrated and fed, to avoid them separating and shrivelling up which results in cracking and twisting. The frequency of oil application required depends on the following factors:

- Level of exposure to the sun
- Level of local rainfall
- The level of UV block provided by the coating • The extent of exposure to the western sun
- Modinex Architectural recommends Cutek oils and the coating must be reapplied frequently as necessary to retain the natural beauty and colour of the timber.

A proactive approach to maintenance is always best. Recoating before any issues become apparent is the best way to ensure longevity. The damage is already done once an issue becomes noticeable.

When the surface loses its water shedding abilities, and water ceases to bead up and run off, this is time to recoat.

